

bio-goods.com

Model: NE-300
“Just Infusion”™

NE-1000 Series of Programmable Syringe Pumps

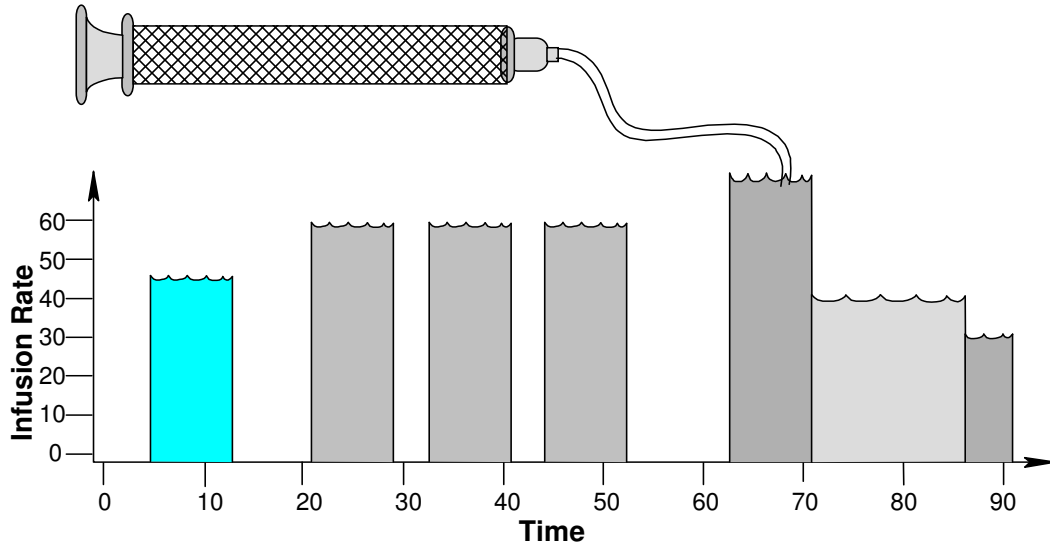

“WHAT’S YOUR APPLICATION?”™



WARNING
NOT FOR CLINICAL
USE ON HUMANS

Quick Start Instructions

- Plug in the pump.
- Press the power switch to turn on power.
- Press any key to stop the display from blinking.

Setup Pumping Parameters



To Change Numbers:

- Press the up-arrow keys  to increment the digit above each key.
- **Move the decimal point:** Simultaneously press the 2 up-arrow keys under the 2 digits next to the decimal point position to set or clear it. Or, press and hold the left-most up-arrow key for at least 1 second. When the digit increments from 9 to 0, the decimal point will begin to shift. Release the key when the decimal point is correct.
- Press any non-arrow key, or wait 2 seconds, to enter the new setting. The display will blink when a valid new value is entered and stored in memory.

Set the Syringe Inside Diameter:

- Momentarily press the  key. Set the inside diameter of the syringe in millimeters (mm). See syringe inside diameter reference chart on the last page.

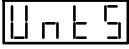
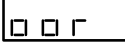

Set the Pumping Rate:

- Momentarily press the  key.
- To change the **pumping rate units:**
 - Momentarily press the  key again. The display will show: 
 - While the units are blinking, press any up-arrow key to select the next available rate units.
 - Press any non-arrow key, or wait 2 seconds, to set the rate units.
- Set the pumping rate. If the pumping rate is out of range, the display will show: 

Load the Syringe

- Press in the white drive-nut button to move the pusher block.
- Lift and turn the syringe clamp away from the syringe holder block.
- Position the syringe on the pump with the flange to the left of the syringe holder block.
- Lift and turn the syringe clamp onto the syringe barrel.
- Move the pusher block next to the syringe plunger.

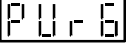
Syringe Purge / Priming

- Press and hold the  key for one second. Release to stop. The display will show:  While infusing at the top speed.
- Press and hold the  key to reverse the pump and release the pusher block if jammed.

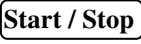
Start the Pump: Momentarily press the  key to start or stop the pump.

While Pumping

- The pumping rate can be changed.

PUMP RESET: Press and hold the right-most up-arrow key while turning on power to the pump.

Need more pumping features?

Visit www.bio-goods.com to see our full-featured syringe pumps.

1. General Information and Packing List

Thank you for purchasing the Model NE-300 “Just Infusion”™ Syringe Pump. With the NE-300 syringe pump you will be able to digitally set an infusion rate for continuous pumping.

Please familiarize yourself with the NE-300’s operation by reading this user’s manual. For future reference, record the serial number, located on the rear of the pump, and the date of purchase.

New Era Pump Systems Inc., located in Farmingdale, NY USA, can be contacted at:

Phone: (631) 249-1392 FAX: (707) 248-2089

WWW.BIO-GOODS.COM

This Operating Manual, and the NE-300’s hardware, electronics and firmware are copyrighted.

Copyright 1999-2016, all rights reserved.













Packing List

Included with the NE-300 Syringe Pump are the following items:



- One of the following external power supply adapters:
Input: One of: 120V AC 60 Hz, 220V AC 50 Hz, 240V AC 50 Hz
Output: 12VDC, 1000 mA, regulated power supply
- This Operating Manual

1.1 Warnings and Cautions

- | | |
|---|---|
| <ul style="list-style-type: none">  Read the user’s manual  No user serviceable parts are inside.  Disconnect power from the pump when connecting or disconnecting cables.  Do not immerse the pump in liquid  Install on a stable surface.  Keep hands and loose clothing away from the pump’s moving parts.  The pump can automatically start when the Pumping Program is operating or when attached to an external control device.  Prevent liquids from entering openings in the rear of the pump. | <ul style="list-style-type: none">  Use only with the supplied power supply connected to a power source as specified on the power supply label.  Do not push objects of any kind into the chassis openings, except for appropriate cables and connectors.  If the pump becomes damaged, do not use unless certified safe by a qualified technician. Damage includes, but is not excluded to, frayed cords and deterioration in performance.  Discharge static from control cables before connecting by touching the cable to ground.  Before touching the pump, discharge static by touching ground. |
|---|---|

1.2 Disclaimer and Warranty

Disclaimer

New Era Pump Systems Inc. makes no representations or warranties, expressed, statutory or implied, regarding the fitness or merchantability of this product for any particular purpose. Further, New Era Pump Systems Inc. is not liable for any damages, including but not limited to, lost profits, lost savings, or other incidental or consequential damages arising from ownership or use of this product, or for any delay in the performance of its obligations under the warranty due to causes beyond its control. New Era Pump Systems Inc. also reserves the right to make any improvements or modifications to the product described in this manual at any time, without notice of these changes.

New Era Pump Systems Inc. products are not designed, intended, or authorized for use in applications or as system components intended to support or sustain human life, as a clinical medical device for humans, or for any application in which the failure of the product could create a situation where personal injury or death may occur.

All brand and product names used in this manual are the trademarks of their respective owners.

Warranty

New Era Pump Systems Inc. warrants this product and accessories for a period of two year, parts and labor, from the date of purchase. The repaired unit will be covered for the period of the remainder of the original warranty or 90 days, whichever is greater.

A return authorization number must be obtained from New Era Pump Systems Inc. before returning a unit for repair. Warranty covered repairs will not be performed without a return authorization number. At the option of New Era Pump Systems Inc., a defective unit will be either repaired or replaced.

This warranty does not cover damage by any cause including, but not limited to, any malfunction, defect or failure caused by or resulting from unauthorized service or parts, improper maintenance, operation contrary to furnished instructions, shipping or transit accidents, modifications or repair by the user, harsh environments, misuse, neglect, abuse, accident, incorrect line voltage, fire, flood, other natural disasters, or normal wear and tear. Changes or modifications not approved by New Era Pump Systems Inc. could void the warranty. Wearable parts, such as drive nuts, are not covered by the warranty.

The foregoing is in lieu of all other expressed warranties and New Era Pump Systems Inc. does not assume or authorize any party to assume for it any other obligation or liability.

2. Overview

The NE-300 is a general purpose single syringe pump capable of infusing at digitally set pumping rates. It is controlled from a microcontroller based system which drives a step motor, allowing a wide range of pumping rates calibrated to the inside diameter of the loaded syringe. The syringe is driven from a drive-screw and drive-nut mechanism.

Features:

- ◆ Infusion pumping of syringes up to 140 mL.
- ◆ Pumping rates from 0.73 μ L/hr with a 1 mL to 1500 mL/hr with a 60 mL syringe.
- ◆ Display of infused volume.
- ◆ Non-volatile memory of all operating parameters.
- ◆ Power Failure Mode: Re-starts pumping after a power interruption.

2.1 Glossary of Terminology and Concepts

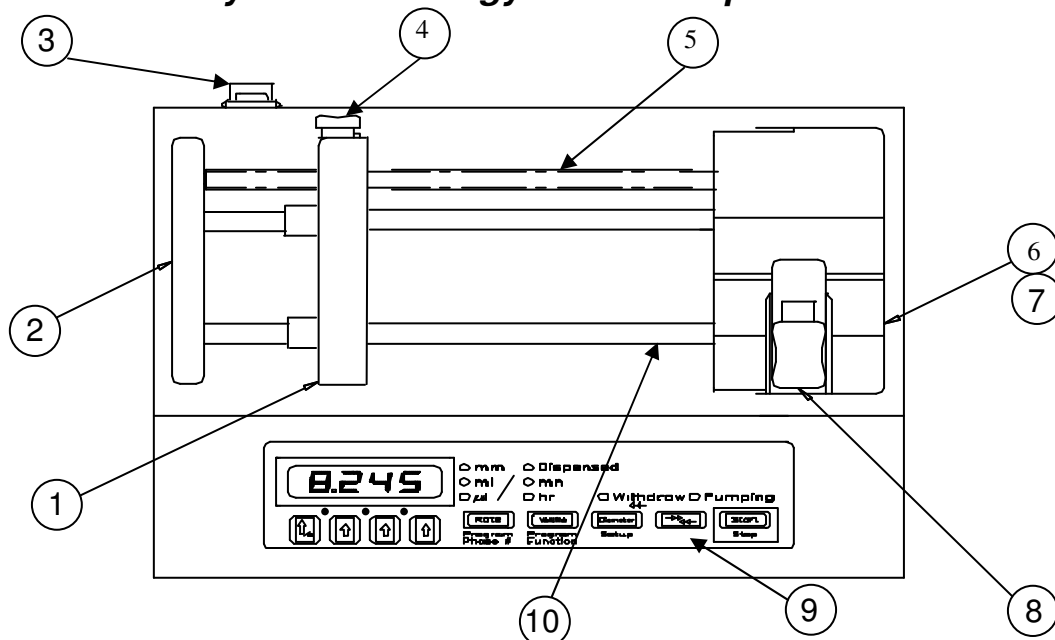

When a device has as many features as the NE-1000 series, understanding its operation could be a daunting task at first. By understanding the key concepts and terminology used in this manual, the operation of the NE-300 will become quite intuitive. Every effort has been made to design the NE-300 with a consistent and intuitive user interface.

To facilitate and enhance your understanding of the NE-300's operation, please take the time to familiarize yourself with the basic concepts below:

Parts of the Pump

- | | |
|------------------------|---------------------------------------|
| 1) Pusher Block | 6) Syringe Holder Block |
| 2) End Plate | 7) 'V' Slot (on Syringe Holder Block) |
| 3) Power On/Off Switch | 8) Syringe Clamp |
| 4) Drive-Nut Button | 9) Keypad / User Interface |
| 5) Drive-Screw | 10) Guide Rod (2 guide rods) |

Parts of a Syringe

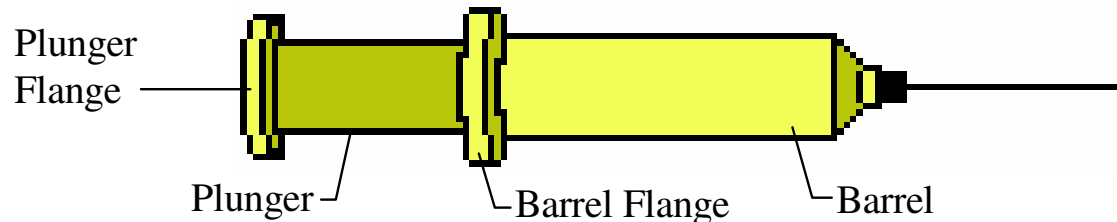

Terminology

- Momentary Press:** A quick press, less than 1 second, and then release of a key on the keypad.
- Display Blink:** A momentary blanking of the LCD display. This indicates that the new data entered by the user is valid and has taken effect.

3. Setup

- ◆ Place the pump on a stable surface.
- ◆ Plug the round connector end of the supplied power supply adapter into the power plug located on the lower right of the pump's rear. See section 8, Rear of Pump, for a diagram of the rear of the pump. Plug the other end of the power supply adapter into an appropriate electrical outlet. The pump will be powered when the bottom of the power switch, located on the upper right of the rear of the pump, labeled '1', is pressed. The red indicator on the switch is visible when the power switch is in the 'on' position. After power is applied to the pump, the pump's display will flash.
- ◆ Next, the Pumping Parameters can be entered. Before the pump can be started, the pump needs the measurement of the inside diameter, in millimeters (mm), of the syringe that will be loaded. The syringe diameter is entered using the keypad on the front panel of the pump.
- ◆ Finally, the syringe can be loaded and the pump started.

4. Loading Syringes

The syringe is loaded by securing the barrel and the pusher flange as follows:

- 1: Press in fully the white **drive-nut button** on the **pusher block**, releasing the block. Taking care not to drag the drive-nut on the drive-screw, slide the block away from the syringe holder, providing sufficient space for the loaded syringe. Then release the white button.
 - 2: Lift the **syringe clamp** above the **syringe holder block**. Turn it 1/4 turn and then lower it onto the syringe holder block. The syringe clamp should be out of the '**V**' slot.
 - 3: Load the syringe with the **barrel** over the syringe holder and the syringe **plunger** towards the middle of the pump. Place the barrel on the syringe holder, in the '**V**' slot, with the **barrel flange** to the left of the syringe holder block.
 - 4: Lift the syringe clamp to slightly above the height of the syringe barrel and then turn the syringe clamp 1/4 turn back to its original position and lower it onto the syringe barrel.
 - 5: Press the white drive-nut button to slide the pusher block against the syringe plunger. Release the white drive-nut button.
- ⇒ To unload the syringe, reverse the instructions for syringe loading.

5. User Interface

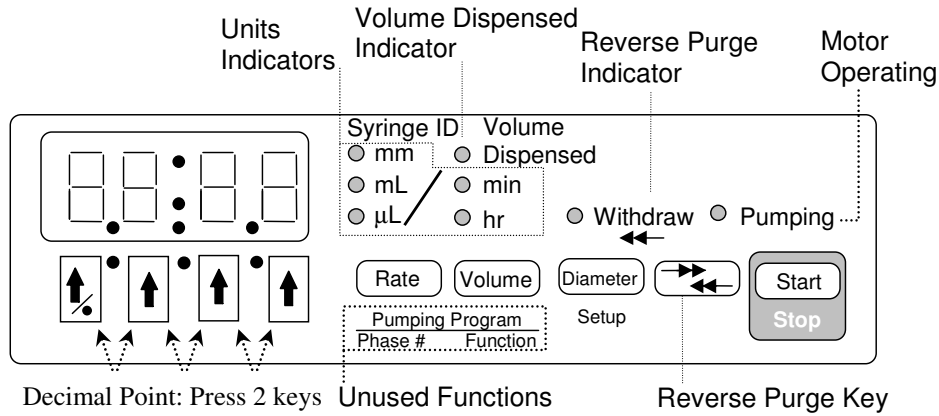

Figure 1: Front Panel

5.1 Entering Values

When applicable, values can be changed by displaying the current value, then using the up-arrow keys. When the display blinks, the new value will be stored in the pump’s non-volatile memory, meaning that the new value will not be lost the next time that power is applied to the pump.

A displayed value can be changed by pressing the up-arrow keys below each digit. To set or clear the decimal point, press the 2 up-arrow keys below the 2 digits next to the decimal point position.

While the current value is being changed, the units LEDs associated with the value, if any, will blink. Except where noted, the new value is stored, and/or the selected operation takes effect, when either

- 1) A non-arrow key is pressed or
- 2) After a 2 second delay since the last arrow key was pressed.

If the new value is valid and different from the original value, the display will blink, indicating that the new value was stored. Otherwise, if the value was invalid, an error message will be displayed. Pressing any key clears the error message and restores the original value.

In general, if a parameter has 2 values, ‘off’ and ‘on’, they are represented by the numbers ‘0’ and ‘1’, respectfully.

5.2 LCD Display

The display consists of a 4 digit reflective LCD display. This is the general purpose user display device for displaying floating point values, functions and parameters. The colon (:) is used for separating function abbreviations from their parameter values.

5.3 LEDs

To the right of the LCD are 8 red, round, LED indicators. The first 2 columns display the units of the displayed values. Units are expressed using 1 or 2 LEDs. For example, ‘mL / hr’ is expressed by lighting the ‘mL’ and the ‘hr’ LEDs.

LED	Description
mm	Millimeters
mL	Milliliters
min	Minutes
µL	Microliters
Hr	Hours
Withdraw ←←	Pumping Direction: Lit: Withdraw Purge Pumping
Dispensed	Displayed volume is dispensed volume
Pumping	Lit: Motor is operating Not lit: The Pump is stopped

Pumping rate units are expressed using 2 LEDs:

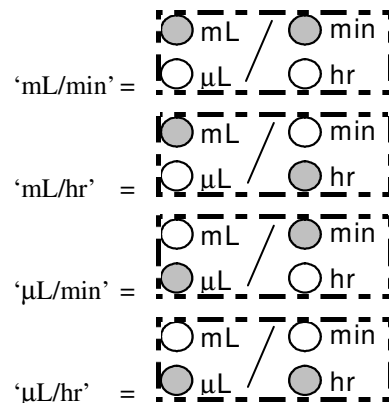

5.4 Up-Arrow Keys and Decimal Point

Each of the four digits in the display is associated with the up-arrow key directly below it. When applicable, the up-arrow key is used to increment the value of that digit, or advance to the next setting.

Each press of up-arrow keys increases digits by 1, up to 9, and then back to 0. Hold down arrow keys for continuous incrementing of digits. With fixed range value parameters, such as on/off parameters, arrow keys scroll up to the maximum value, then back to the minimum value.

When changing a parameter's units, each press of any arrow key will change the unit's LEDs to the next unit selection.

When the display blinks, the new value is stored and takes effect. This will occur when a non-arrow key is pressed or after a 2 second delay since the last key press.

Decimal Point

There are 4 decimal point positions on the LCD display. Each decimal point position is to the right of a digit. The last decimal point position, to the right of the right-most digit, is not displayed, indicating whole numbers with no decimal point.

To set or clear a decimal point, simultaneously press the 2 up-arrow keys under the 2 digits next to the decimal point.

Alternatively, use the left-most up-arrow key / decimal point key (↑/●). Press and hold this key for at least 1 second and wait until the left-most digit scrolls from '9' to '0'. While continuing to hold this key, the decimal point will shift 1 position to the right. After the right-most decimal point position, the decimal point will shift to the first decimal point position. Release the key when the decimal point is in the required position.

5.5 'Diameter' and 'Setup' Key

The 'Diameter' key displays the syringe inside diameter with the 'mm' LED lit. With the pump stopped, use the up-arrow keys to change the diameter setting (see sec. 5.4, Up-Arrow Keys and Decimal Point). The 'mm' LED will blink while the diameter is being changed.

If the 'Diameter' key is pressed and held, 'Setup' mode will be entered. (see sec. 5.10, 'Setup' Key).

5.6 'Rate' Key

The 'Rate' key displays the pumping rate. With the pump stopped, another press of the 'Rate' key will switch between the 'Rate' display and the select rate units mode.

Use the up-arrow keys to change the pumping rate (see sec. 5.4, Up-Arrow Keys and Decimal Point). The rate units will blink while the rate is being changed. If the new pumping rate entered is valid, it takes effect when the display blinks after a 2 second delay or when a non-arrow key is pressed.

See section 9.5, "Syringe Diameters and Rate Limits", for a list of minimum and maximum pumping rates for different syringes. A pumping rate of 0.0 will stop the pump. If the new pumping rate is out of range of the

pumping rate limits for the syringe diameter, the display will show . Pressing any key clears the message and returns to the previous pumping rate.

5.6.1 Pumping Rate Units

The pumping rate units can only be changed when the Pump is stopped. When displaying the pumping rate, a momentary press of the 'Rate' key will enter Rate Units Change mode. The 2 LEDs representing the units will

blink and the display will show: .

Each press of any up-arrow key selects the next rate units, as indicated by the blinking units LEDs. When the required rate units are blinking, press any non-arrow key or wait 2 seconds. The display will blink, indicating the rate units are stored in memory.

5.7 'Volume' Key

The 'Volume' key displays the "Volume Dispensed". The 'Volume Dispensed' LED and the current volume units LED will be lit. The units of the volume are set according to the syringe diameter, but can be changed.

5.7.1 Clearing "Volume Dispensed"

With the pump stopped and displaying the "Volume Dispensed", pressing and holding any up-arrow key for one second will reset the dispensed volume to 0.000.

5.7.2 Changing Volume Dispensed Units

With the “Volume Dispensed” 0.000 displayed, press any up-arrow key to enter “Set Volume Units” mode.

The display will show: and the Volume units LED will blink. Press any up-arrow key to toggle the volume units between ‘mL’ and ‘μL’ while the units LED is blinking.

5.8 Reverse Purge Key

The direction key, ‘’, is used to un-jam the pusher block after an over infusion, making it difficult to release the nut block. Press and hold the direction key for at least 1 second to reverse purge the pump until the pusher block is released. Release this key to stop the pump. While this key is held, the display will show:

. The Withdraw and Pumping LED’s will be lit during the reverse purge.

5.9 ‘Start’/‘Stop’ Key

The ‘Start/Stop’ key starts or stops the Pump’s operation. Pressing this key switches between Pumping and the Pump stopped. The ‘Pumping’ LED will indicate that the Pump is pumping.

Purge Mode: Purge begins after this key is held for one second, and continues until the key is released,

stopping the pump. While purging, the display will show:

5.10 ‘Setup’ Key

The secondary function of the ‘Diameter’ key is ‘Setup’. While the Pump is stopped, press and hold the

‘Diameter’ key until the setup configuration parameter, “Power Failure Mode”, is displayed:

The display will consecutively display, for about 2 seconds, each Setup Configuration parameter and its current setting. Pressing any non-arrow key will immediately advance to the next Setup Configuration parameter, if any.

Press an arrow key under the parameter’s value to change the value. To store the new value, press any non-arrow key or wait 2 seconds. If the parameter value differs from its previous value, the display will blink and the new value will be stored and takes effect immediately.

The next parameter, if any, will then be displayed. After the last parameter, the display reverts back to the syringe diameter. See section 7, Setup Configuration for a complete description of the Setup Configurations.

5.11 Special Power-Up Functions

The following special functions are accessed by pressing the specified key, **while** turning on power to the pump. Then press any key to return to the normal display.

5.11.1 Firmware Version Display

Display the pump’s firmware version: **Left-Most Up-Arrow Key** (/●). Display will show, or similar:

5.11.2 Reset Pumping Parameters

Reset pump’s setup parameters: **Right-Most Up-Arrow key** (). Display will show:

With pumps having as many complex features as the NE-1000 series, it is easy for a novice user experimenting with the pump's setup to get the pump into a 'weird' state. Performing this reset function will bring the pump out of a 'weird' state.

5.12 Error and Status Messages

Value entered is ‘Out Of Range’ of the pump’s operational limits. Verify that the pumping rate and/or the syringe inside diameter setting are correct.

Key pressed is not currently applicable.

Indicates pumping rate or volume units change mode. The units LED's will also be blinking. Press any up-arrow key to change the units.

Indicates that the pump is purging. Displayed while holding down the 'Start/Stop' key.

Indicates a reverse purge. Displayed while holding down the direction key.

6. Operation



Before the pump can be operated, the pumping data must be setup. The syringe inside diameter and a non-zero pumping rate needs to be set. The operation of the pump can then be started by pressing the “Start / Stop” key.

6.1 Syringe Inside Diameter

The syringe inside diameter can only be set while the Pump is stopped. Use the up-arrow keys to set the diameter value. While the diameter value is being set, the ‘mm’ LED will blink. The new diameter value is stored after pressing any non-arrow key, or after a 2 second delay.

Valid syringe diameters are from 0.1 mm to 50.0 mm. If the diameter is out of this range, the display will

show . Pressing any key restores the diameter display to its previous value. Changing the syringe diameter *will not zero the pumping rate*. Section 9.5, “Syringe Diameters and Rate Limits”, is a representative list, for reference, of syringe diameters for various syringe manufacturers and syringe sizes.

6.1.1 Volume Units: Default and How to Change

The units of the accumulated infusion volume is set according to the syringe diameter setting. If the default volume units are changed (see next section), the selected volume units will remain in effect until a reset function is performed.

From 0.1 to 14.0 mm	Syringes smaller than 10 mL:	Volume units are ‘ μ L’
From 14.01 to 50.0 mm	Syringes greater than or equal to 10 mL:	Volume units are ‘mL’

Changing Volume Units

The volume units used for the accumulated volume can be changed to either ‘mL’ or ‘ μ L’. Volume units can only be changed when the pump is stopped.

Display the “Volume Dispensed” by pressing the “Volume” key. The current volume units and the “Dispensed” LED will be lit.

Set the Volume Dispensed to 0.000 if it is not zero: Press and hold any up-arrow key until the Volume

Dispensed is set to 0.000. Then, pressing any up-arrow key will change the display to  and the current volume units will blink.

Now, press any up-arrow key to switch the volume units between ‘mL’ and ‘ μ L’. Press any non-arrow key or wait 2 seconds to enter the new volume units. The display will blink when entered. The selected volume units will remain in effect and override the default volume units. Changing the diameter will no longer change the volume units. Performing a system reset will cancel the override and allow the volume units to change to the default volume units when setting the syringe diameter.

6.2 Operating the Pump

When the “Start/Stop” key is pressed, the Pump will begin pumping, and the ‘Pumping’ LED will be lit. The pump will pump continuously at the set pumping rate until stopped.



Either the pumping rate, “Volume Dispensed”, or syringe diameter can be displayed while pumping. Press the relevant key to change the display. The pumping rate can be changed while pumping.

Warning: The NE-300 does not have stall detection. The pump must be stopped manually when the syringe is empty or if the motor force is exceeded. The white drive nut block can be damaged when the pump is operating while the motor cannot turn. This will void the warranty and replacement of the drive nut block will not be covered.

6.3 Purging

To purge the syringe, with the Pump stopped, press and hold the “Start/Stop” key. The Pump will start pumping, then, after one second, the Pump will pump at its top speed. Purging will continue until the

“Start/Stop” key is released, stopping the pump. While purging the display will show: .

Press and hold the direction key, , to perform a reverse purge. The display will show: .

6.4 Changing the Pumping Rate While Pumping

To change the pumping rate, display the pumping rate, and then use the up-arrow keys. The rate units will blink while the rate is being changed. Rate units cannot be changed while pumping.

The new rate is stored after a 2 second delay or by pressing a non-arrow key. If the new rate is within the operating range of the pump, the display will blink and the new rate will be stored in memory and the pump will begin pumping at the new rate. If the new rate is out of the operating range of the pump, the display will

show . Pressing any key clears the message and restores the previous rate.

6.5 Volume Dispensed

The accumulated Volume Dispensed can be displayed at any time by pressing the Volume key. The display will show the total accumulated volume pumped with the 'mL' or 'µL' LED lit and the 'Dispensed' LED lit. Volume is computed based upon the syringe inside diameter setting.

The "Volume Dispensed" accumulation is **reset to 0** when:

- With the pump stopped, pressing and holding any up-arrow key while displaying the volume.
- The syringe diameter is changed.
- The accumulated Volume Dispensed rolls over from 9999 to 0.
- The pump is powered on.

7. Setup Configuration

To change or view the setup configuration, the Pump must be stopped. Press and hold the 'Diameter'/'Setup' key until the first parameter is displayed. After 2 seconds, or when any non-arrow key is pressed, the next parameter will be displayed. (See sec. 5.10, 'Setup' Key). Pressing an arrow key under a value will change the parameter. The following will be displayed:

 **Power Failure Mode.** Where 'n' is the current setting: '0' = Disabled, '1' = Enabled.

When enabled, if the Pump was pumping when power to the pump was disrupted, the Pump will automatically start pumping when power is reconnected to the pump. The accumulated volume will be reset to 0. Pressing any key on the keypad while powering up the pump will stop the Pump from starting in Power Failure Mode.

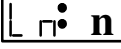
 **Low Noise Mode.** Where 'n' is the current setting: '0' = Disabled, '1' = Enabled.

A side effect of the NE-300's high precision micro-stepped motor driver are high frequency tones at very low pumping speeds. This mode minimizes the tones by reducing the micro-stepping, increasing pulsations.

8. Rear of Pump

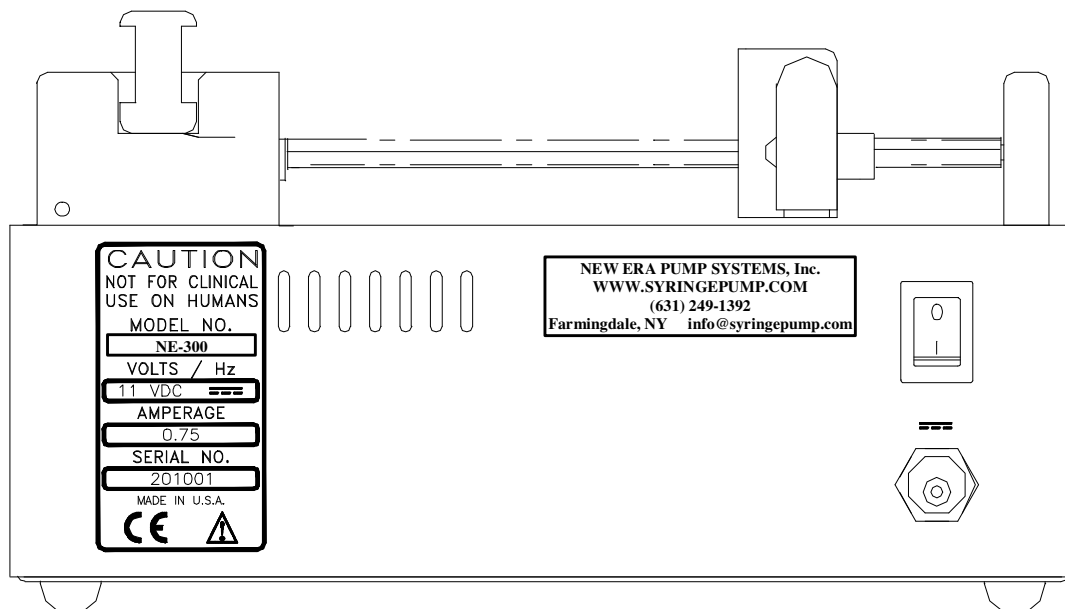

Figure 2: Rear of Pump

9. Appendix

9.1 Accessories

9.1.1 Syringes and Plumbing Supplies

See www.SyringePump.com for an assortment of syringes and plumbing supplies

9.1.2 Syringe Heater

See www.SyringeHeater.com for details.

Flexible heating pads that wraps around the syringe. Thermo-Kinetic Heat Clamping controller will heat a syringe to a set temperature up to 100 C.

9.1.3 Firmware and Hardware Upgrade

Contact your dealer about upgrading your pump with other features from the NE-1000 Programmable Syringe Pump Series. See www.SyringePump.com

9.2 Troubleshooting and Maintenance

Maintenance: Periodically, a small amount of all-purpose oil should be applied to the guide rods and lead screw.

The mechanism should be kept clean to prevent impeded operation. No other special maintenance or calibrations are needed

Pusher block makes a snap or click sound when the pump is started: This is a normal condition. When the pusher block is manually moved, the drive-nut may not have been fully engaged on the drive screw. The sound heard is the drive-nut engaging on the drive screw.

9.3 Specifications

Mechanical & Electrical

Syringe sizes:	Up to 60 mL. 140 mL partially filled.
Number of syringes:	1
Motor type:	Step motor
Motor steps per revolution:	400
Micro-stepping:	1/8 to 1/2 depending on motor speed
Advance per step:	0.2126 μm to 0.8504 μm depending on motor speed
Motor to drive screw ratio:	15/28
Drive screw pitch:	20 revolutions/”
Power connector:	2.1 mm, center positive, DC
Voltage at power connector:	12V DC
Amperage:	750 mA maximum
Power supply type:	External wall adapter, country and power source specific
Power supply output rating:	12V DC, 1000 mA regulated
Dimensions:	8 3/4” x 5 3/4” x 4 1/2” (L x W x H) (22.86 cm x 14.605 cm x 11.43 cm)
Weight:	3.6 lbs. (1.63 kg)
	<u>Operational</u>
Accuracy	Within +/- 1% over length of syringe, exclusive of syringe variations.
Reproducibility	+/- 0.1%
Maximum speed:	3.7742 cm/min
Minimum speed:	0.004205 cm/hr
Maximum pumping rate:	1257 mL/hr with a B-D 60 mL syringe
Minimum pumping rate:	0.73 μL /hr with a B-D 1 mL syringe
Maximum force:	35 lbs. at minimum speed, 18 lbs. at maximum speed
Syringe inside diameter range:	0.100 to 50.00 mm

9.4 Custom Applications

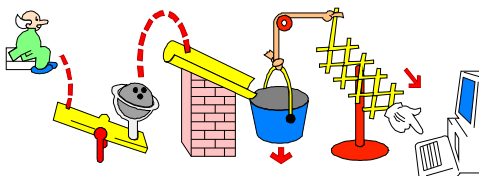

For specialized and OEM applications, contact your dealer or New Era Pump Systems Inc. Custom modifications can be made to the mechanics or the firmware.

9.5 Syringe Diameters and Rate Limits

Syringe Manufacturer (all names ™)	Syringe (mL)	Inside Diameter (mm)	Maximum Rate (mL/hr)	Minimum Rate (µL/hr)	Maximum Rate (mL/min)			
B-D	1	4.699	39.27	0.73	0.654			
	3	8.585	131	2.434	2.184			
	5	11.99	255.6	4.748	4.261			
	10	14.43	370.3	6.876	6.172			
	20	19.05	645.4	11.99	10.75			
	30	21.59	829	15.4	13.81			
	60	26.59	1257	23.35	20.95			
HSW Norm-Ject	1	4.69	39.11	0.727	0.651			
	3	9.65	165.6	3.076	2.76			
	5	12.45	275.6	5.119	4.594			
	10	15.9	449.6	8.349	7.493			
	20	20.05	714.9	13.28	11.91			
	30	22.9	932.6	17.32	15.54			
Monoject	1	5.74	58.59	1.088	0.976			
	3	8.941	142.1	2.64	2.369			
	6	12.7	286.8	5.326	4.78			
	12	15.72	439.4	8.161	7.324			
	20	20.12	719.9	13.37	11.99			
	35	23.52	983.8	18.27	16.39			
	60	26.64	1262	23.44	21.03			
	140	38	2568	47.69	42.8			
Terumo	1	4.7	39.28	0.73	0.654			
	3	8.95	142.4	2.646	2.374			
	5	13	300.5	5.581	5.009			
	10	15.8	443.9	8.244	7.399			
	20	20.15	722.1	13.41	12.03			
	30	23.1	949	17.63	15.81			
	60	29.7	1568	29.13	26.14			
Poulten & Graf (Glass)	1	6.7	79.83	1.483	1.33			
	2	8.91	141.1	2.622	2.353			
	3	9.06	145.9	2.711	2.433			
	5	11.75	245.5	4.559	4.092			
	10	14.67	382.7	7.107	6.379			
	20	19.62	684.6	12.72	11.41			
	30	22.69	915.6	17.01	15.26			
	50	26.96	1292	24.01	21.54			
Steel Syringes	1	9.538	161.7	3.005	2.696			
	3	9.538	161.7	3.005	2.696			
	5	12.7	286.8	5.326	4.78			
	8	9.538	161.7	3.005	2.696			
	20	19.13	650.8	12.09	10.84			
	50	28.6	1454	27.01	24.24			
SGE (gas tight)	Syringe (µL)	Inside Diameter (mm)	Maximum Rate (µL/hr)	Minimum Rate (µL/hr)	Syringe (mL)	Inside Diameter (mm)	Maximum Rate (mL/hr)	Minimum Rate (µL/hr)
	5	0.343	209.2	0.004	0.25	2.303	9.432	0.176
	10	0.485	418.3	0.008	0.5	3.257	18.86	0.351
	25	0.728	942.5	0.018	1	4.606	37.73	0.701
	50	1.03	1886	0.036	2.5	7.284	94.36	1.752
100	1.457	3775	0.071	5	10.3	188.6	3.504	
Hamilton Microliter	0.5	0.103	18.86	0.001	10	14.57	377.5	7.01
	1	0.146	37.91	0.001	25	23.03	943.2	17.52
	2	0.206	75.47	0.002	50	27.5	1344	24.98
	5	0.326	189	0.004	100	34.99	2177	40.43